

## **ADJUSTABLE PRECISION SHUNT REGULATOR**

### ■ Features

- Precision reference voltage  
AP431A : 2.495V ± 0.5%
- Sink current capability: 200mA
- Minimum cathode current for regulation: 300 μA
- Equivalent full-range temp coefficient: 30 ppm/°C
- Fast turn-on response
- Low dynamic output impedance: 0.2Ω
- Programmable output voltage to 36V
- Low output noise.
- Packages: TO-92, SOT-23, SOT-25 and SOP-8  
SOT-89
- RoHS Compliant & Halogen Free Product

### ■ Description

The AP431A are 3-terminal adjustable precision shunt regulators with guaranteed temperature stability over the applicable extended commercial temperature range. The output voltage may be set at any level greater than 2.495V( $V_{REF}$ ) up to 36V merely by selecting two external resistors that act as a voltage divider network. These devices have a typical output impedance of 0.2Ω. Active output circuitry provides very sharp turn-on characteristics, making these devices excellent improved replacements for Zener diodes in many applications. The precise (+/-) 1% Reference voltage tolerance of the AP431A make it possible in many applications to avoid the use of a variable resistor, consequently saving cost and eliminating drift and reliability problems associated with it.

### ■ Ordering Information

A P 4 3 1 A X - X

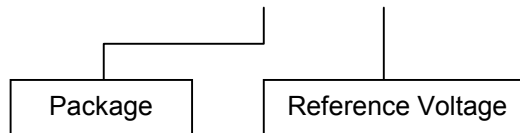

T : TO-92  
N/NR : SOT-23  
Y : SOT-25  
M : SOP-8  
G : SOT-89

Tolerance :  
A : +/- 0.5%  
B : +/- 1%

### ■ Typical Application Circuit

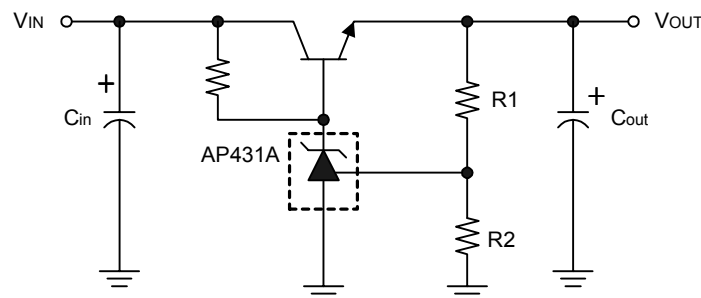

$$V_{OUT} = (1 + R1/R2)V_{REF}$$

Precision Regulator



■ **Block Diagram**

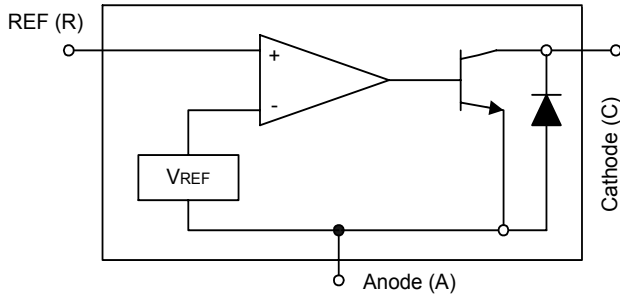

■ **Symbol**

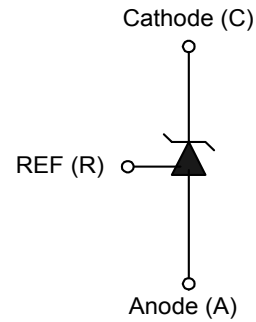

■ **Pin Configuration**

Order Number	Pin Configuration ( Top View )	Order Number	Pin Configuration ( Top View )
<p><b>AP431AT</b> ( TO-92 )</p> <p>Rthja=160°C/W Rthjl=60°C/W</p>	<p>3 Cathode 2 Anode 1 REF</p>	<p><b>AP431AN</b> ( SOT-23 )</p> <p>Rthja=500°C/W Rthjc=180°C/W</p>	<p>Anode 3 2 Cathode 1 REF</p>
<p><b>AP431AM</b> ( SO-8 )</p> <p>Rthja=208°C/W Rthjc=50°C/W</p>	<p>Cathode 1 Anode 2 Anode 3 NC 4 5 NC 6 Anode 7 Anode 8 REF</p>	<p><b>AP431AY</b> ( SOT-23-5L )</p> <p>Rthja=500°C/W Rthjc=180°C/W</p>	<p>NC 1 NC 2 Cathode 3 4 REF 5 Anode</p>
<p><b>AP431AG</b> ( SOT-89 )</p> <p>Rthja=250°C/W Rthjc=110°C/W</p>	<p>3 Cathode Anode 1 REF 2</p>	<p><b>AP431AY5</b> ( SOT-23-5L )</p> <p>Rthja=500°C/W Rthjc=180°C/W</p>	<p>REF 1 Anode 2 Cathode 3 4 NC 5 NC</p>
<p><b>AP431ANR</b> ( SOT-23 )</p> <p>Rthja=500°C/W Rthjc=180°C/W</p>	<p>Anode 3 2 REF 1 Cathode</p>		



■ **Absolute Maximum Ratings**

Cathode Voltage .....	36V
Continuous Cathode Current .....	-10mA ~ 250mA
Reference Input Current Range .....	10mA
Operating Temperature Range .....	-40°C ~ 85°C
Lead Temperature.....	260°C
Storage Temperature .....	-65°C ~ 150°C
Power Dissipation (Notes 1, 2)	
TO-92 Package .....	0.78W
SOT-23 Package .....	0.25W
SOT-25 Package.....	0.25W
SOP-8 Package.....	0.6W
SOP-89 Package.....	0.5W

Note 1: T<sub>J</sub>, max = 150°C

Note 2: Ratings apply to ambient temperature at 25°C

■ **Electrical Characteristics** (T<sub>a</sub>=25°C , unless otherwise specified.)

PARAMETER	TEST CONDITIONS	SYMBOL	MIN.	TYP.	MAX.	UNIT
Reference voltage	V <sub>KA</sub> = V <sub>REF</sub> , I <sub>KA</sub> = 10mA (Fig.1)	-B -A V <sub>REF</sub>	2.470 2.482	2.495	2.520 2.507	V
Deviation of Reference input voltage over temperature (Note 3)	V <sub>KA</sub> = V <sub>REF</sub> , I <sub>KA</sub> = 10mA, T <sub>a</sub> = Full range (Fig.1)	V <sub>REF</sub>		8.0	20	mV
Ratio of the change in Reference voltage to the change in Cathode voltage	I <sub>KA</sub> = 10mA (Fig.2)	V <sub>KA</sub> = 10V ~V <sub>REF</sub>		-1.4	-2.0	mV/V
		V <sub>KA</sub> = 36V ~10V		-1	-2	mV/V
Reference input current	R1 = 10KΩ, R2 = ∞ I <sub>KA</sub> = 10mA (Fig.2)	I <sub>REF</sub>		1.4	3.5	μA
Deviation of Reference input current over temperature	R1 = 10KΩ, R2 = ∞ I <sub>KA</sub> = 10mA T <sub>a</sub> = Full range (Fig.2)	αI <sub>REF</sub>		0.4	1.2	μA
Minimum Cathode current for regulation	V <sub>KA</sub> = V <sub>REF</sub> (Fig.1)	I <sub>KA(MIN)</sub>		0.19	0.5	mA
Off-state current	V <sub>KA</sub> = 36V, V <sub>REF</sub> = 0V (Fig.3)	I <sub>KA(OFF)</sub>		0.1	1.0	μA
Dynamic output impedance (Note 4)	V <sub>KA</sub> = V <sub>REF</sub> Frequency ≤ 1KHz (Fig.1)	Z <sub>KA</sub>		0.2	0.5	Ω

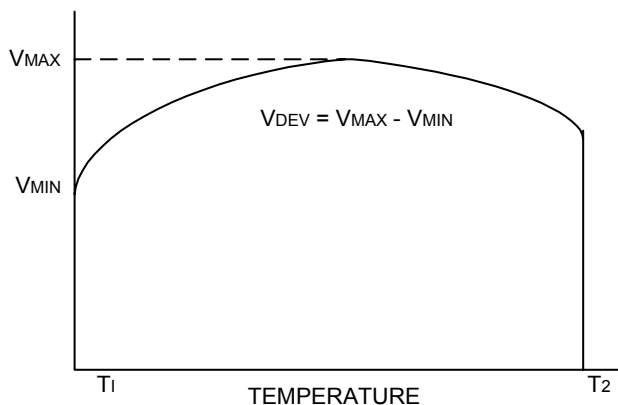

Note 3. Deviation of reference input voltage,  $V_{DEV}$ , is defined as the maximum variation of the reference over the full temperature range.

The average temperature coefficient of the reference input voltage  $\alpha V_{REF}$  is defined as:

$$|\alpha V_{REF}| = \frac{\left(\frac{V_{DEV}}{V_{REF}(25^{\circ}\text{C})}\right) \cdot 10^6}{T_2 - T_1} \dots\dots\dots (\text{ppm}/^{\circ}\text{C})$$

Where:

$T_2 - T_1$  = full temperature change.

$\alpha V_{REF}$  can be positive or negative depending on whether the slope is positive or negative.

Note 4. The dynamic output impedance,  $R_Z$ , is defined as:

$$|Z_{KA}| = \frac{\Delta V_{KA}}{\Delta I_{KA}}$$

When the device is programmed with two external resistors  $R_1$  and  $R_2$  (see Figure 2.), the dynamic output impedance of the overall circuit, is defined as:

$$|Z_{KA}'| = \frac{\Delta v}{\Delta i} \approx |Z_{KA}| \left(1 + \frac{R_1}{R_2}\right)$$

**■ Test Circuits**

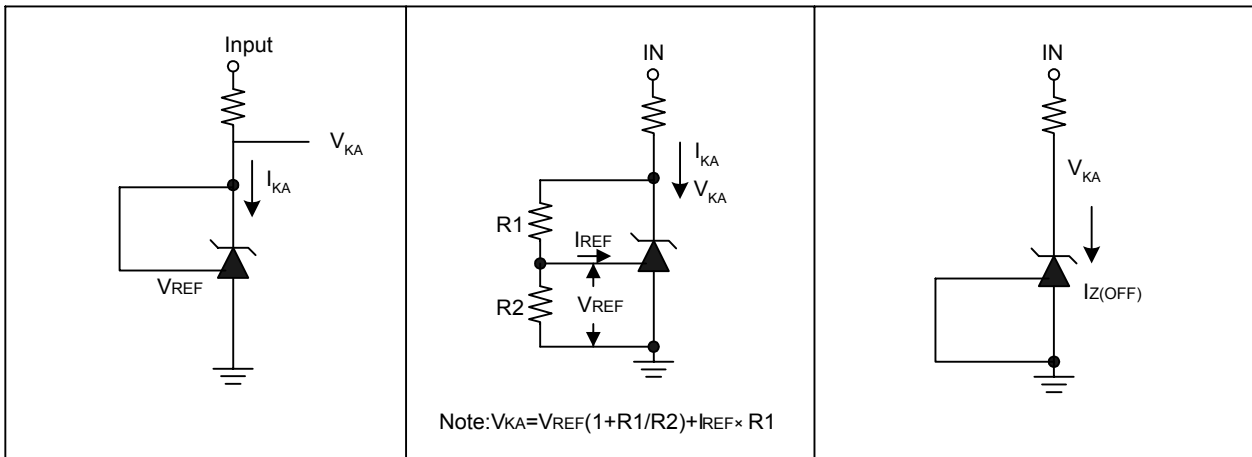

Fig1. Test Circuit for  $V_{KA} = V_{REF}$

Fig2. Test circuit for  $V_{KA} > V_{REF}$

Fig3. Test Circuit for off-state Current



■ Typical Performance Characteristics

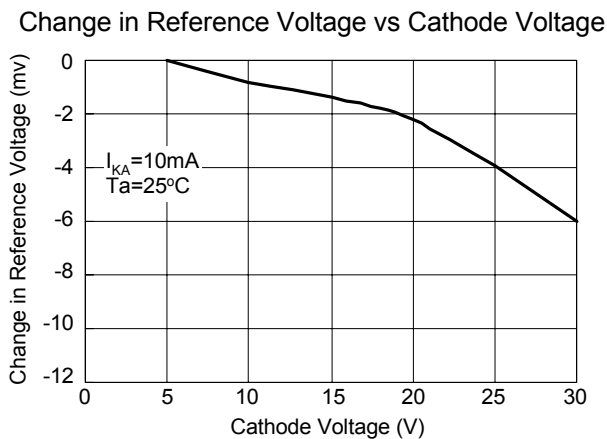
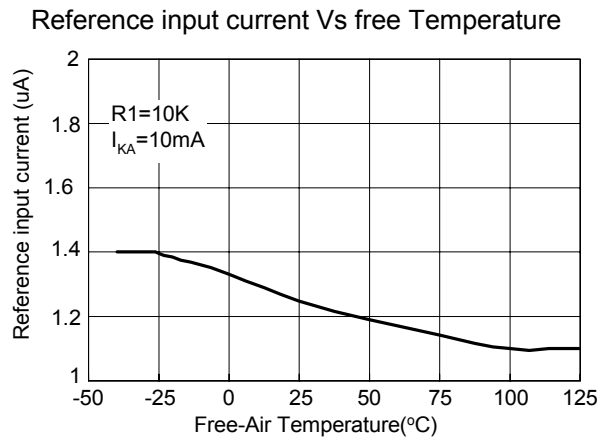
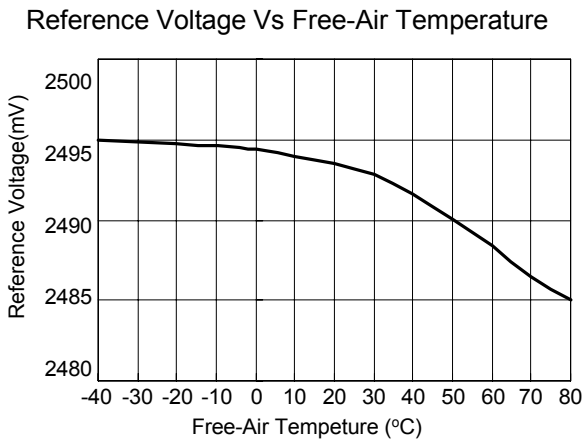
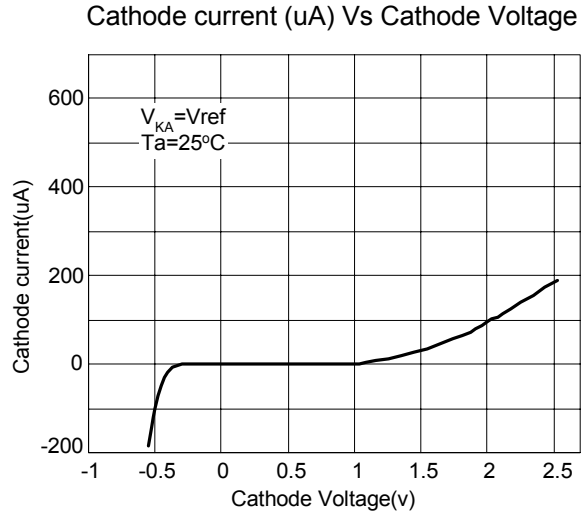
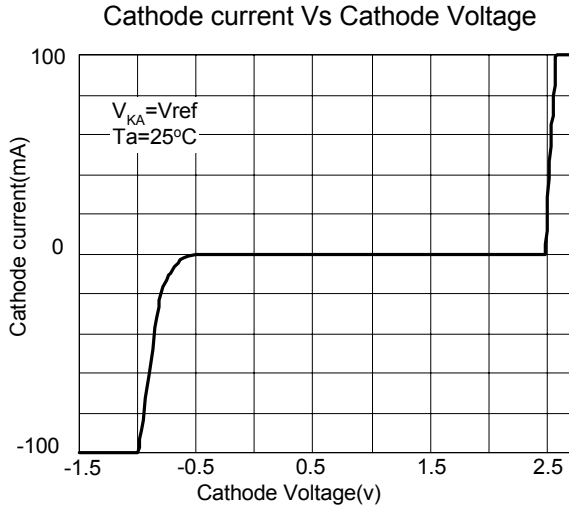



### ■ Typical Performance Characteristics(Continued)

SMALL-SIGNAL VOLTAGE AMPLIFICATION vs. FREQUENCY

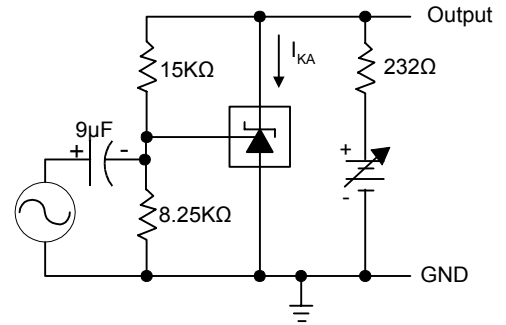
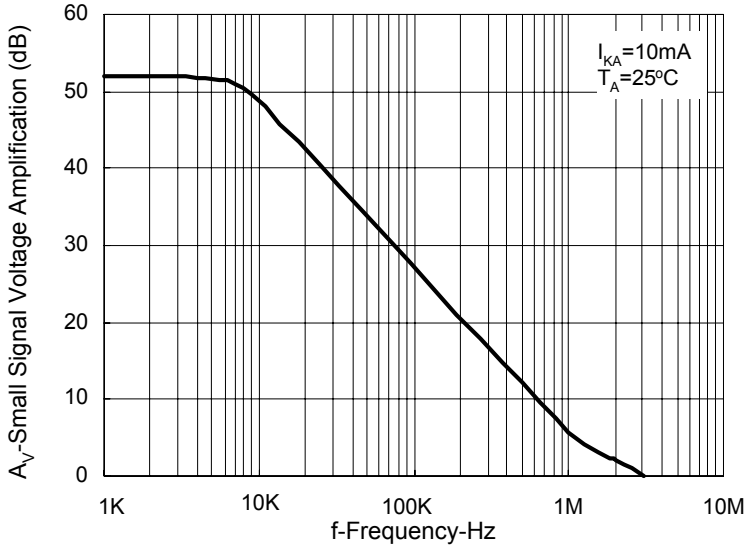

TEST CIRCUIT FOR VOLTAGE AMPLIFICATION

REFERENCE IMPEDANCE vs. FREQUENCY

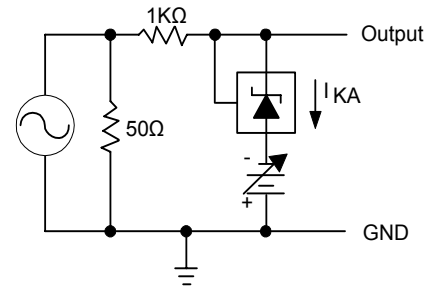
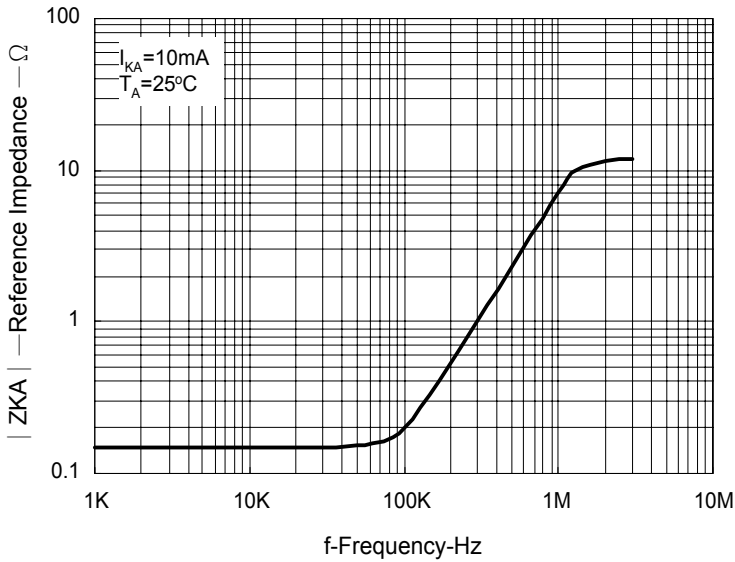

TEST CIRCUIT FOR REFERENCE IMPEDANCE



PULSE RESPONSE

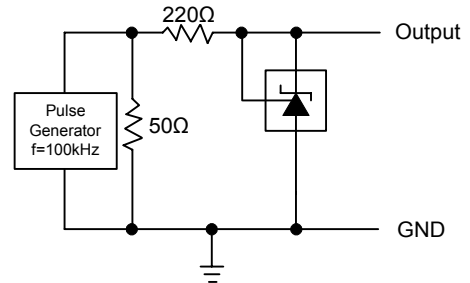
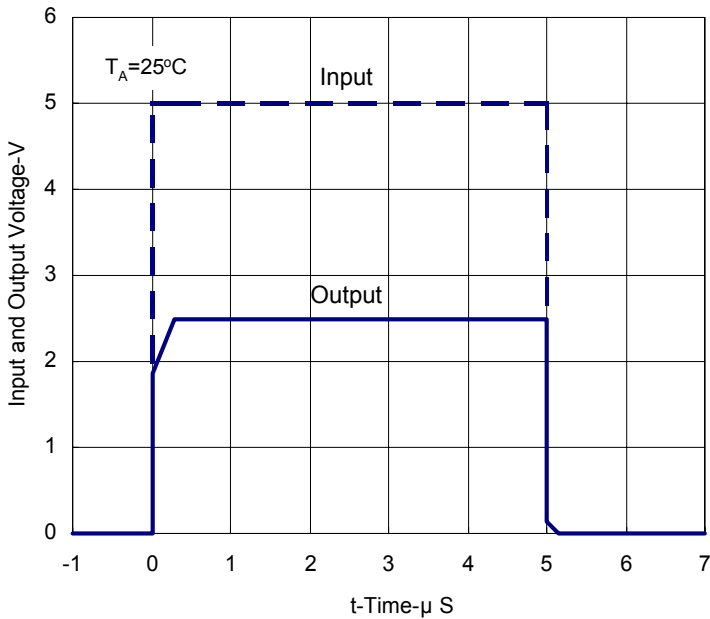

TEST CIRCUIT FOR PULSE RESPONSE

STABILITY BOUNDARY CONDITIONS†

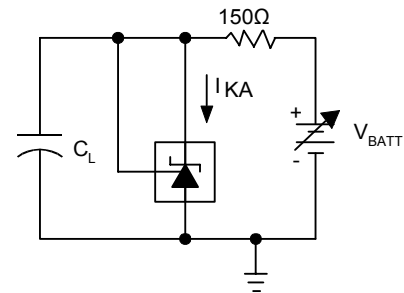
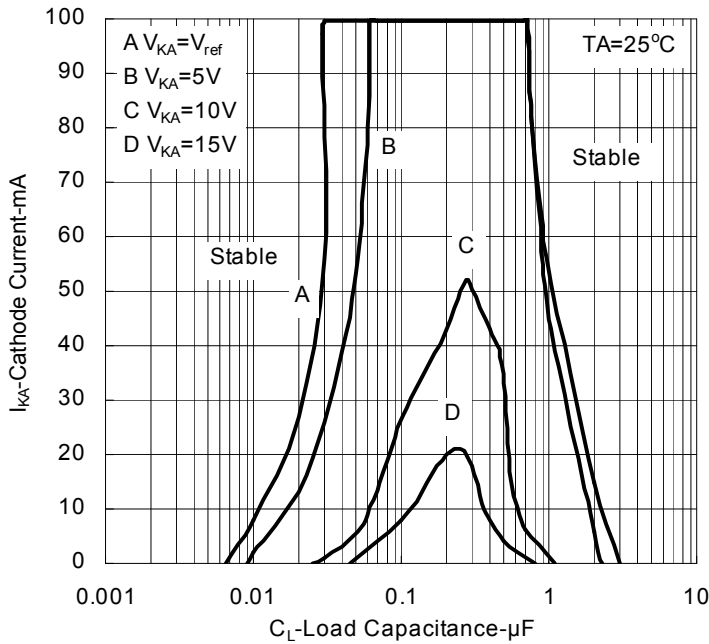

TEST CIRCUIT FOR CURVE A

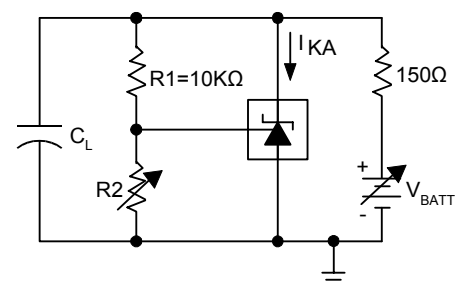

TEST CIRCUIT FOR CURVE B, C, AND D

†The areas under the curves represent conditions that may cause the device to oscillate. For curves B, C, and D,  $R_2$  and  $V_+$  were adjusted to establish the initial  $V_{KA}$  and  $I_{KA}$  conditions with  $C_L=0$ .  $V_{BATT}$  and  $C_L$  were then adjusted to determine the ranges of stability.

■ **Application Examples**

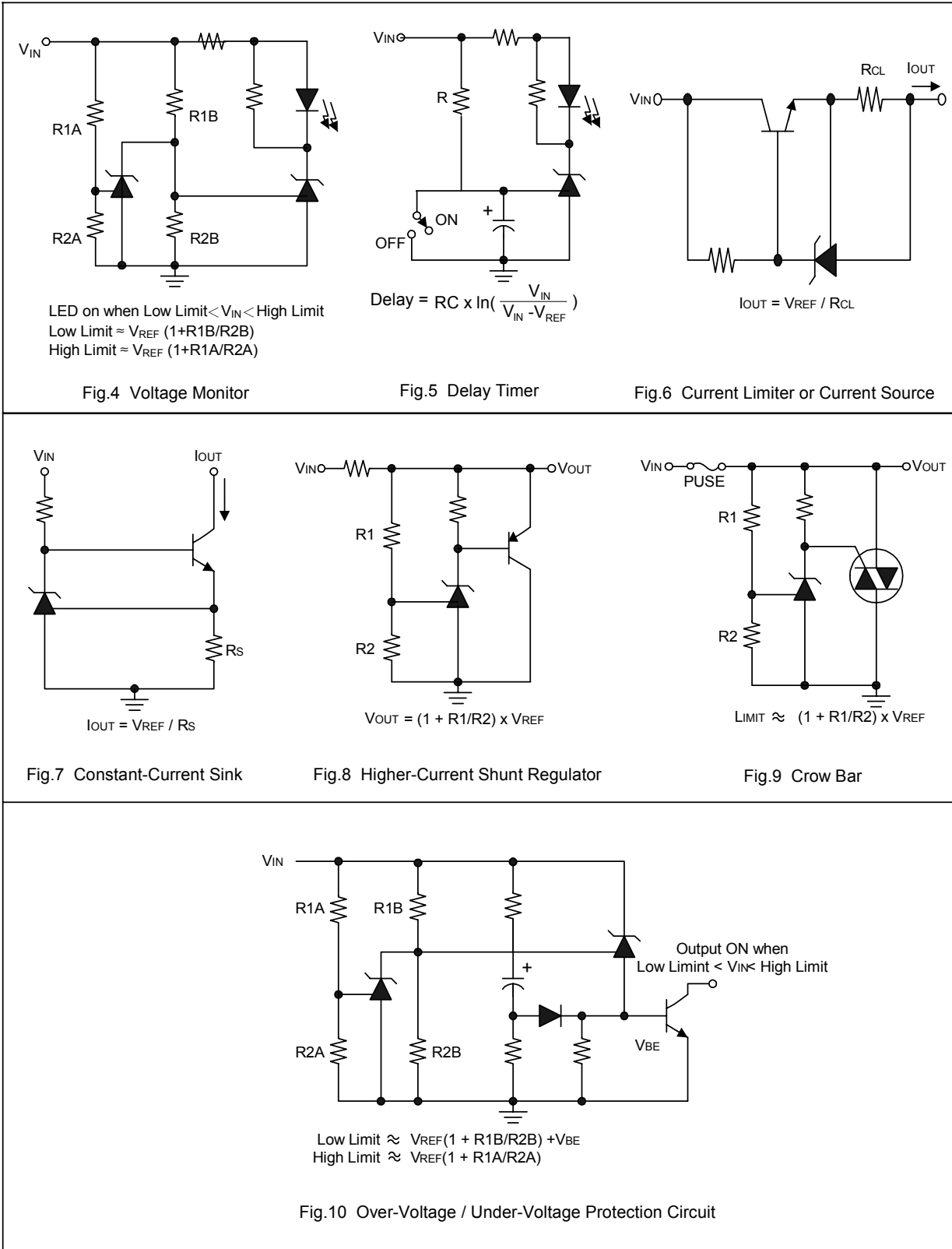





MARKING INFORMATION

SO-8

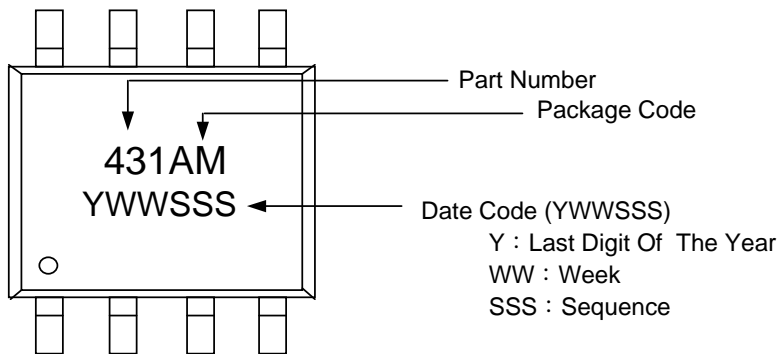

SOT-23-5L

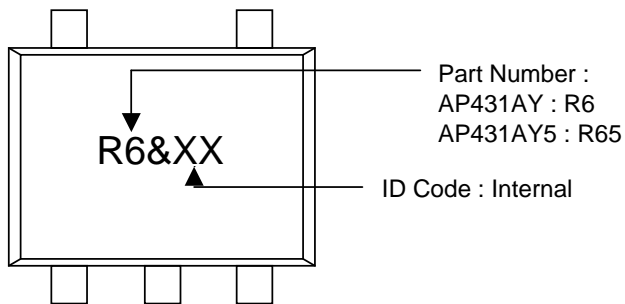

SOT-23

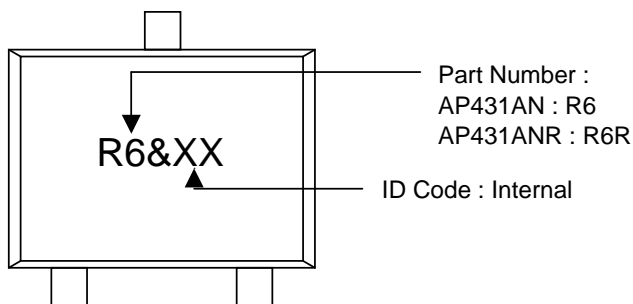

SOT-89

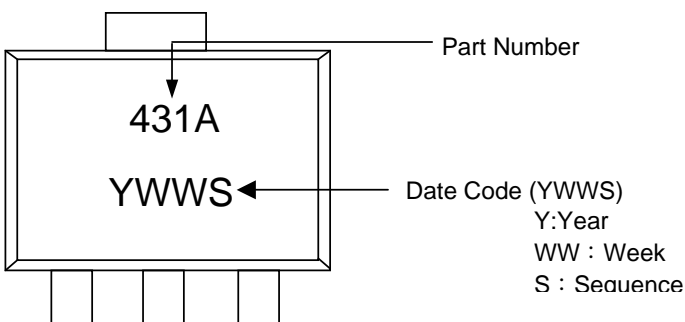



---

**MARKING INFORMATION**

TO-92

